

INSTALLATION & OPERATING INSTRUCTIONS

TTL Driver Boards for 3200 & 3250 Series Programmable Attenuators



(P/N 101-1704-000, 101-1705-000,
101-1798-000, 101-1798-001 & 101-1804-000)

This documentation may not be reproduced in any form, for any
purpose unless authorized in writing by API / Weinschel, Inc.

api 
technologies corp.
> WEINSCHEL
© **API / Weinschel, Inc.**
Frederick, Maryland
1998, 2001, 2004

GENERAL

This manual provides general installation instructions and wiring data to be used as an aid in installing the TTL Driver Board Kits onto a API / Weinschel 3200 and 325C Series Programmable Attenuators. Also included are specifications and other technical data to help in the installation and operation of your 3200 Programmable Attenuator with the TTL Driver Board installed.



DESCRIPTION

These driver boards are designed to provide a TTL interface for a wide range of API / Weinschel's existing relay based programmable attenuators. The boards will mount directly onto the control terminals of the programmable attenuator and can be permanently secured by soldering the TTL Driver Board to the feedthroughs of the programmable.

These Driver Boards are available in two types with either a 10/14 pin ribbon cable connector (Option -1) or a 15 pin "D" connector (Option -2) This option fits limited models, refer to list below). Each type is supplied with a mating connector. Refer to Physical Dimensions for mating connector pin/wiring details. Two wires are specified for supply voltage and ground. The remaining wires will accept TTL control signals to activate or de-activate a particular attenuation cell. A TTL high will energize a cell to the high attenuation state, whereas a TTL low will maintain a cell in its zero attenuation state.

Basic Model No.	TTL BD Kit Part No. 10 Pin Ribbon	TTL BD Part No. 15 Pin "D" CONN
3200-1, 3200-1E	101-1780	101-1798-000
3200-2, 3200-2E	101-1780	101-1798-000
3201-1, 3201-2E	101-1781	101-1798-001
3201-2, 3201-4	101-1781	101-1798-001
3205-1, 3205-2	101-1781	101-1798-001
3205-3, 3205-3E	101-1781	101-1798-001
3206-1, 3206-3E	101-1781	N/A
3209-1	101-1804-000	N/A
3250-X	101-1705-000	N/A
101-1780 (kit)	101-1704-000	N/A
101-1781 (kit)	101-1705-000	N/A

Schematic for TTL Driver Board (Option -1) with 10 pin Ribbon Connector (P/N 101-1704-000 & 101-1705-000):

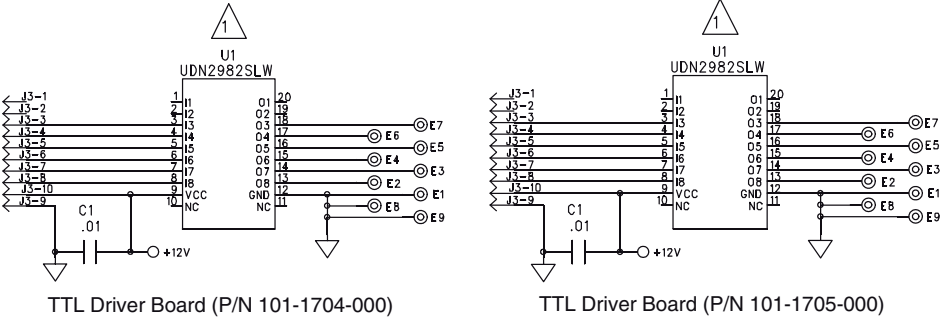

Schematic for TTL Driver Board (Option -1) with 14 pin Ribbon Connector (P/N 101-1804-000):

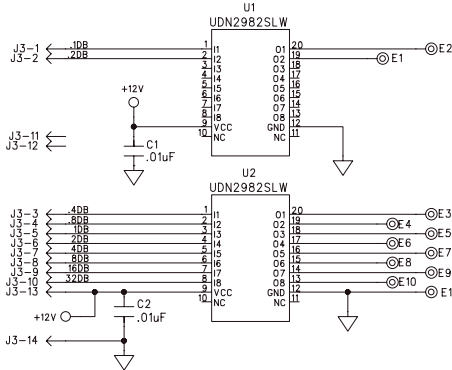

Schematic for TTL Driver Board (Option -2) with 15 pin D Connector (P/N 101-1798-000 & 101-1798-001):

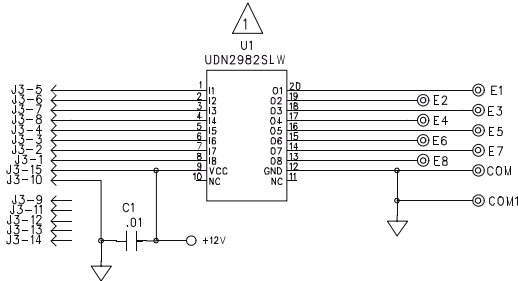

NOTES:

1. ALTERNATE PIN OUT FOR U1, 18 PIN IC P/N TD62783.

U1 TD62783			
1	11	01	18
2	12	02	17
3	13	03	16
4	14	04	15
5	15	05	14
6	16	06	13
7	17	07	12
8	18	08	11
9	VCC	GND	10

2. E8 AND COM NOT CONNECTED ON 101-1798-001 ASSY.

INSTALLATION

MOUNTING: If not previously installed, using the Physical Dimension drawings carefully slide the TTL Driver Board directly onto the appropriate control terminals of the programmable attenuator. Permanently secure by soldering them to the feedthroughs. Trim feedthroughs (optional).

CONTROL CONNECTOR WIRING: The Tables below show the connector's contact pin numbering scheme and the cell number/dB value at each contact pin of the control connector. Cell numbers are generally read from J1 to J2, with the most significant cell number being adjacent to the ground terminal.

10 Pin Ribbon Control Connector J3 Pin Locations:

TTL Conn PIN No. (J3)	3200-1-1 dB (Cell)	3200-2-1 dB (Cell)	3201-1-1 dB (Cell)	3201-2-1 dB (Cell)	3201-4-1 dB (Cell)	3205-1-1 dB (Cell)	3205-2-1 dB (Cell)	3205-3-1 dB (Cell)	3206-1-1 dB (Cell)	3250-63-1 dB (Cell)
1	32	0.25	NC	NC	NC	NC	NC	NC	NC	NC
2	1	0.5	NC	NC	NC	NC	NC	NC	NC	NC
3	2	1	1	30	0.1	NC	NC	NC	32	32
4	32*	2	2	10	0.2	10	5	0.1	1	1
5	4	4	4	30**	0.3	20	10	0.2	2	2
6	8	8	8	20	0.6	20	20	0.4	4	4
7	16	16	16	30**	NC	20	20	0.8	8	8
8	32*	32	NC	NC	NC	NC	NC	NC	16	16
9	COM	COM	COM	COM	COM	COM	COM	COM	COM	COM
10	+Vcc	+Vcc	+Vcc	+Vcc	+ Vcc	+ Vcc	+Vcc	+ Vcc	+Vcc	+Vcc

15 Pin "D" & 14 Pin Ribbon Control Connector J3 Pin Locations:

"D" Conn PIN No. (J3)	3200-1-2 dB (Cell)	3200-2-2 dB (Cell)	3201-1-2 dB (Cell)	3201-2-2 dB (Cell)	3201-4-2 dB (Cell)	3205-1-2 dB (Cell)	3205-2-2 dB (Cell)	3205-3-2 dB (Cell)	Cable*** Color Code	3209-1-1 dB (Cell)
1	32	32	NC	NC	NC	NC	NC	NC	BRN	0.1
2	16	16	NC	NC	NC	NC	NC	NC	YEL	0.2
3	8	8	NC	NC	NC	NC	NC	NC	GRN	0.4
4	4	4	16	30**	NC	20	20	0.8	LT BLU	0.8
5	32	0.25	1	30**	0.1	NC	NC	NC	VIO	1
6	1	0.5	2	10	0.2	10	5	0.1	GRY	2
7	2	1	4	30	0.3	20	10	0.2	WHT	4
8	32*	2	8	20	0.6	20	10	0.4	WHT/BLK	8
9	NC	NC	NC	NC	NC	NC	NC	NC	RED	16
10	GND	GND	GND	GND	GND	GND	GND	GND	BLK	32
11	NC	NC	NC	NC	NC	NC	NC	NC	---	NC
12	NC	NC	NC	NC	NC	NC	NC	NC	---	NC
13	NC	NC	NC	NC	NC	NC	NC	NC	---	+Vcc
14	NC	NC	NC	NC	NC	NC	NC	NC	---	GND
15	+Vcc	+Vcc	+Vcc	+Vcc	+ Vcc	+Vcc	+Vcc	+Vcc	ORN	

*64 dB cell comprised of two 32 dB cells

**60 dB cell comprised of two 30 dB cells

***Cable (P/N 101-1805) supplied with opt 2

NC = Not Connected

SPECIFICATIONS

INTERFACE CONNECTOR: Option -1 (Models 3200, 3201, 3205 and 3206): 10 pin .025 square post header on .1 center, mates with Amp connector 746285-1 or equivalent. Option -1 (3209): 14 pin .025 square post header on .1 center, mates with Amp connector 746285-2 or equivalent.

Option -2: 15 pin D Socket Connector, mates with Cannon connector DA-15S or equivalent.

INPUT VOLTAGE:

VIN High=	+2.0V minimum +5.0V typical Vcc maximum
VIN Low =	0 minimum 0.8 maximum

INPUT CURRENT:

IIN ($V_{IN}=2.4\text{ V}$)	= 55 mA
IIN ($V_{IN}=3.85\text{ V}$)	= 280 mA

SUPPLY CURRENT (Digital Section): ICC=25.0 mA maximum

SUPPLY CURRENT (per cell continuous): ICC=25.0 mA maximum for 2 GHz models and 30 mA per cell for 3 GHz models.

SUPPLY VOLTAGE: VCC=+12.0 to +15V

TEMPERATURE RANGE (Operating): -40°C to +70°C

CONTACTING API / Weinschel

In the event you're having difficulty or believe that the components are defective, please contact API / Weinschel immediately. An apparent malfunction may be corrected over the phone by contacting the Customer Service Department at API / Weinschel. DO NOT send the product back to the factory without prior authorization (RMA number). When it is necessary to return an item, state the symptoms or problems, catalog and type number of the attenuator, and date of original purchase. Also write the company name, your name, and phone number on an index card. Then attach the card to the attenuator to be returned.

For more information or any questions about the TTL Driver Boards, your Programmable Step Attenuators and/or other API / Weinschel products, contact the Sales Department at API / Weinschel.

PHYSICAL DIMENSIONS:

TTL OPTION -1 (3200, 3201, 3206):

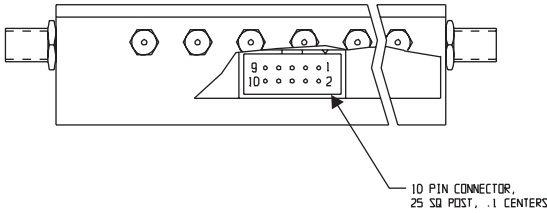
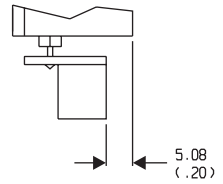
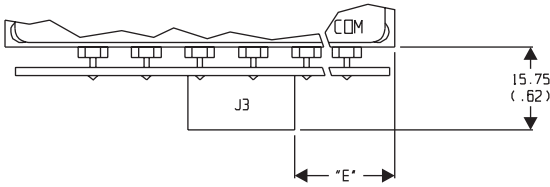

Model No.	E
3200-X-1	37.8 (1.49)
3201-X-1	18.8 (0.74)
3206-X-1	18.8 (0.74)

TTL OPTION -1 (3205):

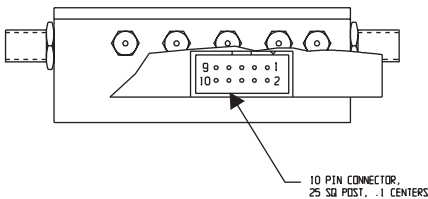
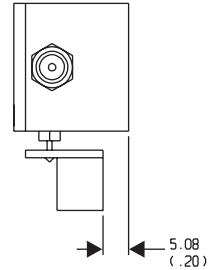
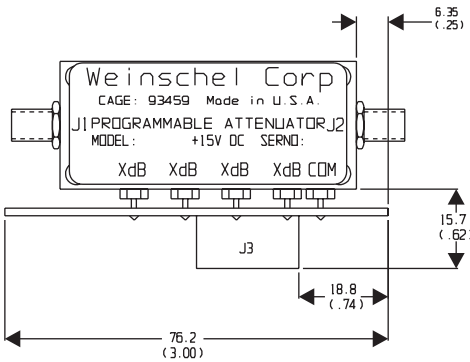

NOTE: All dimensions are given in mm (inches) and are maximum, unless otherwise specified.

TTL OPTION -1 (3209):

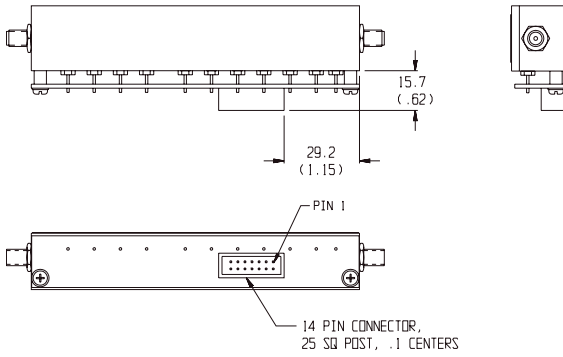

TTL Driver Option -1 (3250):

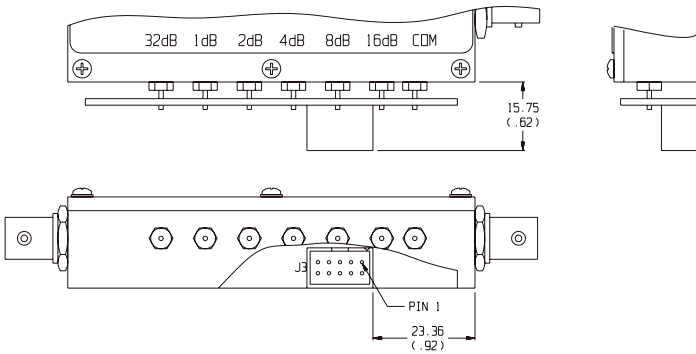

TTL Driver Option -2 (3200, 3201, 3205):

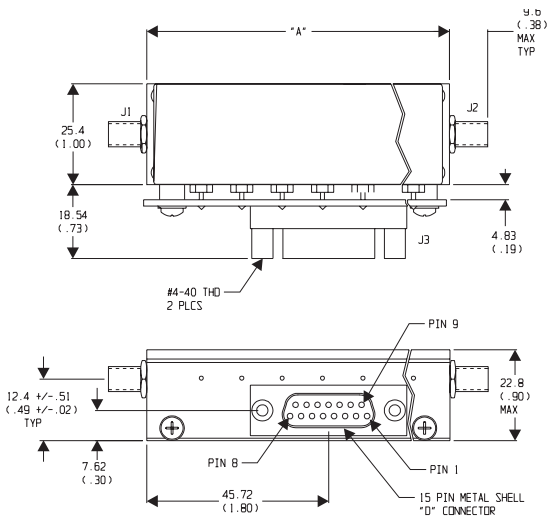

API / Weinschel Warranty

PRODUCTS: API / Weinschel warrants each product it manufactures to be free from defects in material and workmanship under normal use and service anywhere in the world. API / Weinschel 's only obligation under this Warranty is to repair or replace, at its plant, any product or part thereof that is returned with transportation charges prepaid to API / Weinschel by the original purchaser within ONE YEAR from the date of shipment.

The foregoing Warranty does not apply to, and in API / Weinschel's sole opinion, products that have been subject to improper or inadequate maintenance, unauthorized modifications, misuse, or operation outside the environmental specifications for the product.

SOFTWARE PRODUCTS: API / Weinschel software products are supplied without representation or Warranty of any kind. API / Weinschel, therefore, assumes no responsibility and will not accept liability (consequential or otherwise) arising from the use of program materials, disk, or tape.

The Warranty period is controlled by the Warranty document furnished with each product and begins on the date of shipment. All Warranty returns must be authorized by API / Weinschel prior to their return.

API / Weinschel's Quality System Certified to:

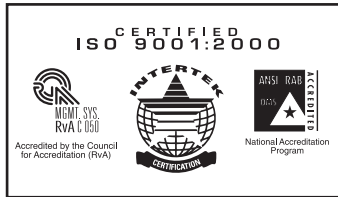

Certificate No. 289e

api 
technologies corp.
> WEINSCHTEL

5305 Spectrum Drive, Frederick, Maryland 21703-7362
TEL: (301) 846-9222, 800-638-2048, FAX: (301) 846-9116
Web: www.weinschel.apitech.com, e-mail: weinschel-sales@apitech.com